



DUKERS
Quality Commercial Refrigeration



REACH IN FREEZER

D47EF

Bottom Mounted / 2-Solid Door











i TECHNICAL SPECIFICATIONS

Voltage/Frequency 110V/60Hz
Refrigerant R290
Type of Defrost Automatic
Interior Material Stainless Steel
Exterior Material Stainless Steel
Temperature Range °F 0 ~ -8°F
Compressor Power (HP) 3/4
Nema Config. NEMA5-15P



PRODUCT FEATURES

-  Equipped with Locking Doors
-  The compressor is mounted in the bottom for better heat evaporation.
-  Digital temperature controls with LED display for precise adjustment and automatic defrosting system.
-  Temperatures in the cabinet range from 0 ~ -8° degrees Fahrenheit
-  R290 Natural Refrigerant promotes faster cool down and efficient energy consumption.
-  Epoxy coated wire shelves.
-  Stainless steel interior & exterior, sealed interior floors, and rounded cabinet corners for easy cleaning.
-  High quality coated stainless adjustable shelves prevent peel and rust.
-  Lifetime warranty on hinges.
-  Adjustable front locking casters.



**HIGH QUALITY
STAINLESS STEEL &
ROBUST DESIGN**



DUKERS

Los Angeles | San Francisco | Dallas
Houston | Florida | Chicago | New Jersey

 1-800-931-8628

 info@dukersusa.com

www.DukersUSA.com

DETAILS & SPECIFICATIONS

D47EF

Front View

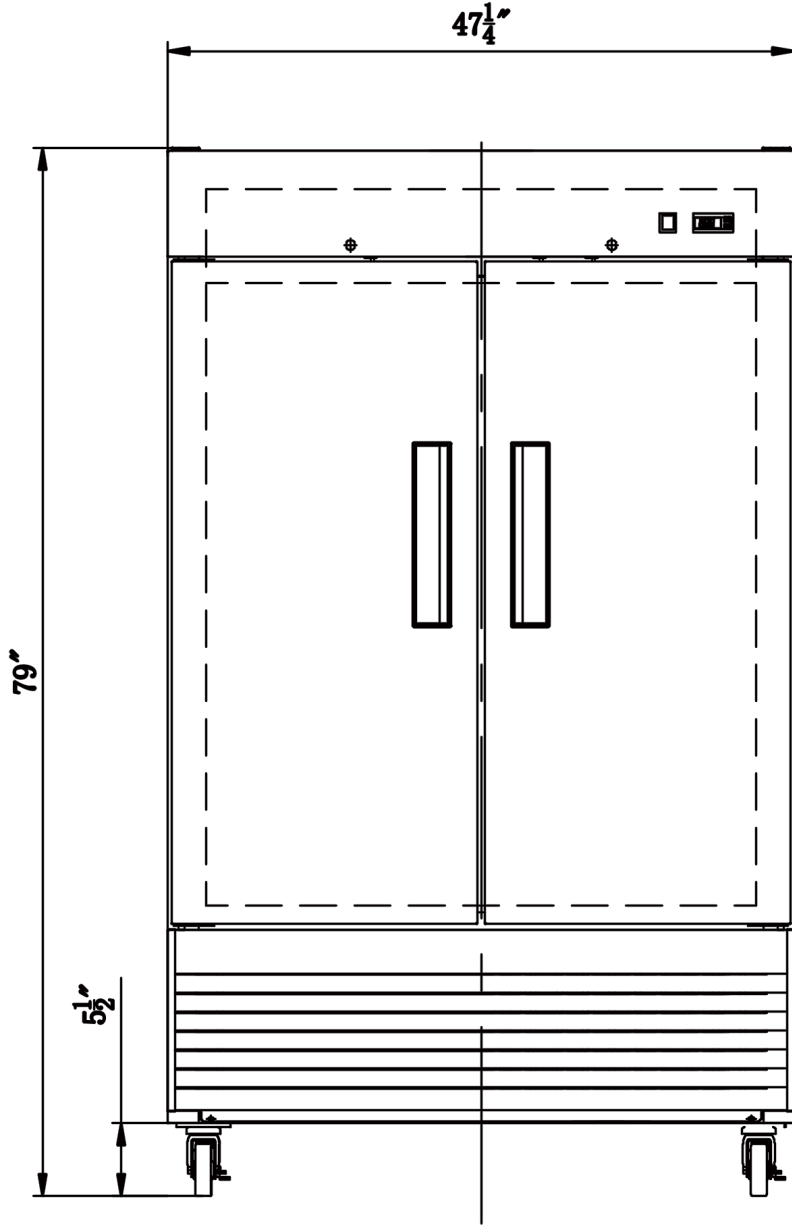

Side View

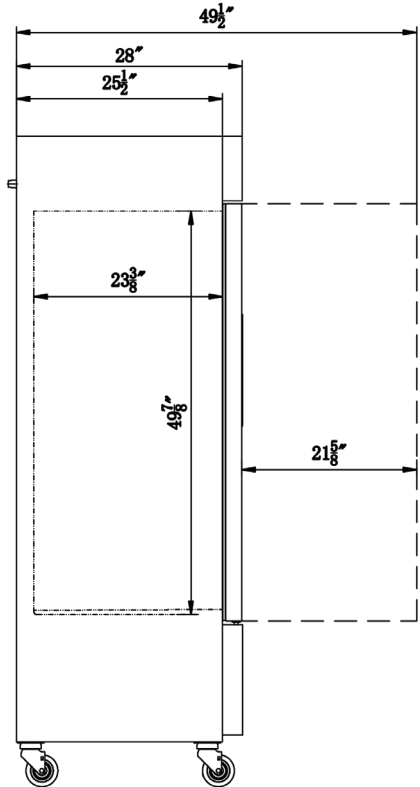

MODEL D47EF

Rated Voltage	110V
Rated Frequency	60Hz
Total Capacity	29.51 cu ft
Insulation Blowing Gas	C-Pentane
Refrigerant	R290

MODEL	EXTERNAL DIMENSION WXDXH (INCHES)	PACKAGING DIMENSION WXDXH (INCHES)	PRODUCT NET WEIGHT	# OF SHELVES	40HQ CONTAINER CERT.
D47EF	47 1/4 x 28 x 79	48 7/8 x 30 x 83	308 lbs	6	28



Los Angeles | San Francisco | Dallas
Houston | Florida | Chicago | New Jersey

1-800-931-8628

@ info@dukersusa.com

www.DukersUSA.com