



# BOTTLE COOLERS



Thermometer



Bottle opener









DHBC50 / DHBC65



DHBC36



## PRODUCT FEATURES

-  Equipped with electronic controls, users can adjust the temperature from 33 to 38 degrees Fahrenheit
-  Heavy duty Cubigel compressor with environmentally friendly R290 refrigerant
-  Easy glide stainless steel lid(s) with handle(s)
-  Bottle opener & cap catcher standard
-  Wire dividers standard
-  Pre-installed casters
-  Lid lock(s) standard



## TECHNICAL SPECIFICATIONS

Voltage/Frequency	110V/60Hz
Refrigerant	R290
Type of Defrost	Automatic
Interior Material	Stainless Steel
Exterior Material	Stainless Steel
Temperature Range °F	33 ~ 38°
Compressor Power (HP)	1/5
Nema Config.	NEMA5-15P



ENVIRONMENTALLY FRIENDLY  
**R290**



HIGH QUALITY STAINLESS STEEL &  
**ROBUST DESIGN**

# DETAILS & SPECIFICATIONS

Side View

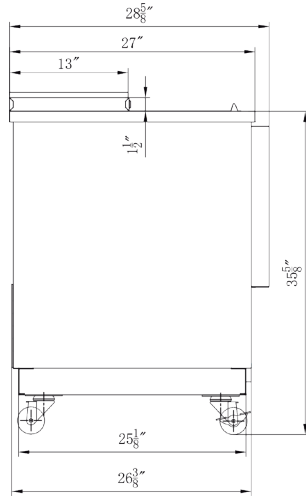

DHBC36  
Front View

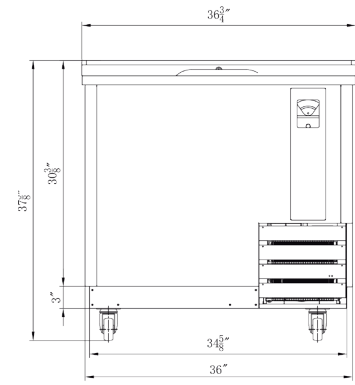

Top View

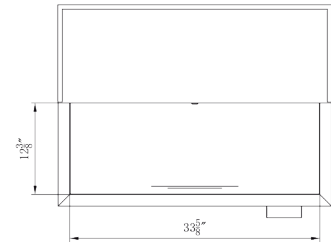

FDHBC50  
Front View

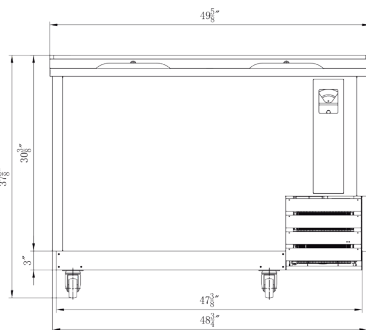

Top View

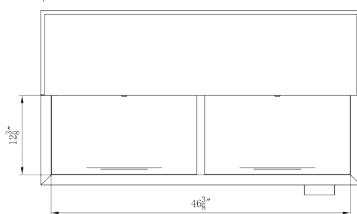

DHBC65  
Front View

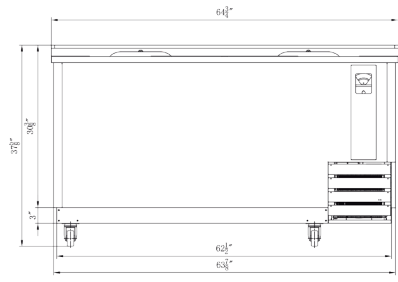

Top View

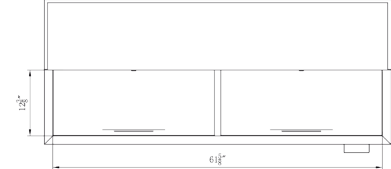

115/60/1  
NEMA-5-15P



Model	External Dimensions (inches)			External Dimensions (inches)			Temperature Range °F	Volume		Electric Current (A)	Power (W)	Net Weight (Kg)	Gross Weight (Kg)	40FT (PCS)
	W	D	H	W	D	H		L	cu.ft					
DHBC36	36 6/8"			38 3/8"			33~41°F	223	7 7/8"	2.00	250	70	85	56
DHBC50	49 5/8"	28 5/8"	37 5/8"	51 1/8"	31 7/8"	41"		326	11 1/2"	2.20	260	80	99	44
DHBC65	64 6/8"			66 3/8"				448	15 5/6"	2.40	280	100	120	28

\* All measures are presented in inches and pounds



Los Angeles | San Francisco | Dallas  
Houston | Florida | Chicago | New Jersey

1-800-931-8628

@ info@dukersusa.com

www.DukersUSA.com