



**DUKERS**  
Commercial Refrigeration  
Equipment



**DUKERS**  
Quality Commercial Refrigeration



## GLASS DOOR MERCHANDISER

DSM-48R

2-Door / Glass / Swing / Refrigerator









### TECHNICAL SPECIFICATIONS

Voltage/Frequency  
115V/60Hz  
Refrigerant  
R290  
Type of Defrost  
Automatic  
Interior Finish  
White  
Exterior Finish  
Black  
Temperature Range °F  
33 ~ 40°F  
Compressor Power (HP)  
1/2 -  
Nema Config.  
NEMA5-15P



### PRODUCT FEATURES

-  The compressor is mounted in the bottom for better heat evaporation.
-  Digital temperature controls with LED display for precise adjustment and automatic defrosting system.
-  Temperature Range 33 ~ 40°F, with auto defrost function, which ensures optimal performance day-in and day-out.
-  R290 Natural Refrigerant promotes faster cool down and efficient energy consumption.
-  Interior and canopy LED light with switch on the right side to always show your products at their best
-  High quality coated stainless adjustable shelves prevent peel and rust.
-  Anti-fogging tempered glass door helps ensure a crystal clear view of the interior.



### HIGH QUALITY & ROBUST DESIGN

**DUKERS**

Los Angeles | San Francisco | Dallas  
Houston | Florida | Chicago | New Jersey

 1-800-931-8628

 [info@dukersusa.com](mailto:info@dukersusa.com)

[www.DukersUSA.com](http://www.DukersUSA.com)

# DETAILS & SPECIFICATIONS

## DSM-48R

Front View

Side View

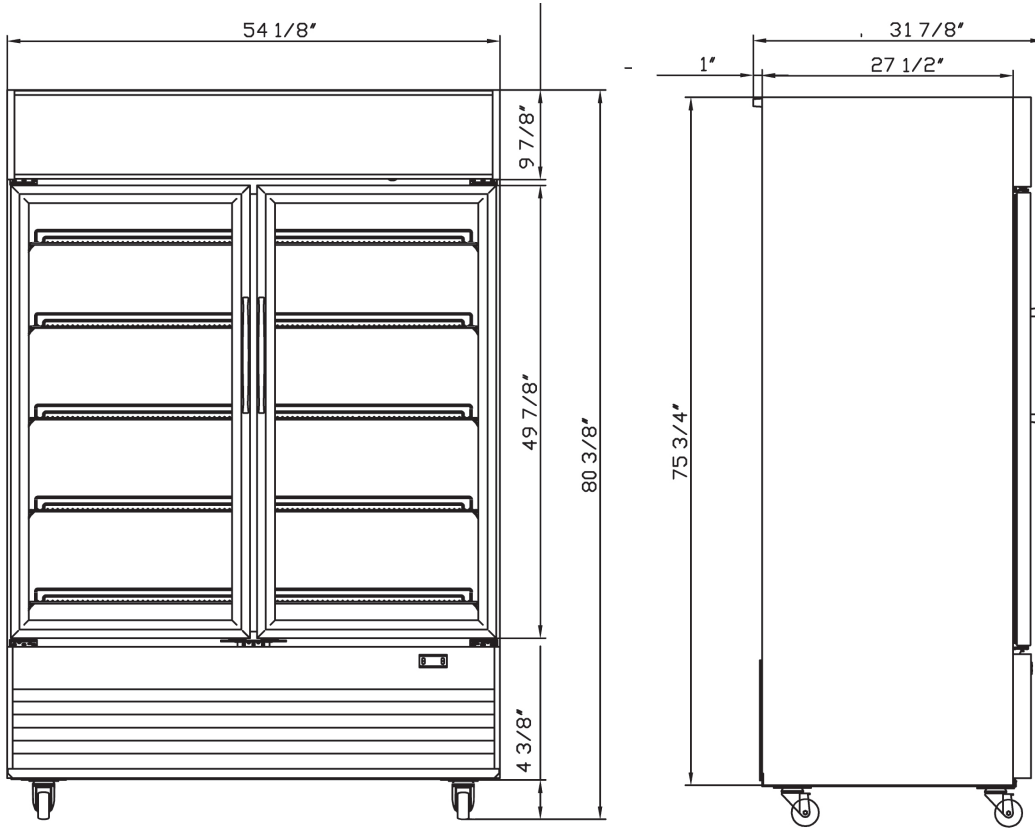

### MODEL DSM-48R

Rated Voltage	115V
Rated Frequency	60Hz
Total Input Power	690W
Total Current	9.8A
Total Capacity	48.73 cu ft
Climatic Category	4-5
Protection Type	I
Design Pressure High Side	300 PSIG
Design Pressure Low Side	150 PSIG
Insulation Blowing Gas	C-Pentane
Refrigerant	R290/5.11 oz

MODEL	EXTERNAL DIMENSION WXDXH (INCHES)	PACKAGING DIMENSION WXDXH (INCHES)	PRODUCT NET WEIGHT	# OF SHELVES	40HQ CONTAINER CERT.
DSM-48R	54 1/8 x 31 7/8 x 80 3/8	56 1/8 x 32 7/8 x 82 3/8	385 lbs	10	



AutoQuotes



115/60/1  
NEMA-5-15P



Los Angeles | San Francisco | Dallas  
Houston | Florida | Chicago | New Jersey

1-800-931-8628

@ info@dukersusa.com

www.DukersUSA.com