



# DUKERS

Quality Commercial Refrigeration



## SALAD PREP TABLE

DSP60-24M-S2

2-Door / Mega Top



### TECHNICAL SPECIFICATIONS

Voltage/Frequency	115V/60Hz
Refrigerant	R290
Type of Defrost	Automatic
Interior Material	Stainless Steel
Exterior Material	Stainless Steel
Temperature Range °F	33 ~ 41°F
Compressor Power (HP)	1/5
Nema Config.	NEMA5-15P



### PRODUCT FEATURES

- The compressor is mounted in the back and placed in the coolest possible area; this makes it easily accessible for servicing.
- Digital temperature controls with LED display for precise adjustment and automatic defrosting system.
- Temperatures in the cabinet range from 33 to 41 degrees Fahrenheit
- Higher Resistance to dust, high quality condenser.
- R290 Natural Refrigerant promotes faster cool down and efficient energy consumption.
- Self-closing doors at 60° with stay open feature.
- Stainless steel interior & exterior, sealed interior floors, and rounded cabinet corners for easy cleaning.
- 6" deep 1/6 plastic plan included.
- High quality coated stainless adjustable shelves prevent peel and rust.
- Lifetime warranty on hinges.
- 6" casters with lock for easy mobility.



### HIGH QUALITY STAINLESS STEEL & ROBUST DESIGN



# DUKERS

Los Angeles | San Francisco | Dallas  
Houston | Florida | Chicago | New Jersey

1-800-931-8628

@ info@dukersusa.com

www.DukersUSA.com

# DETAILS & SPECIFICATIONS

## SALAD PREP TABLE DSP60-24M-S2

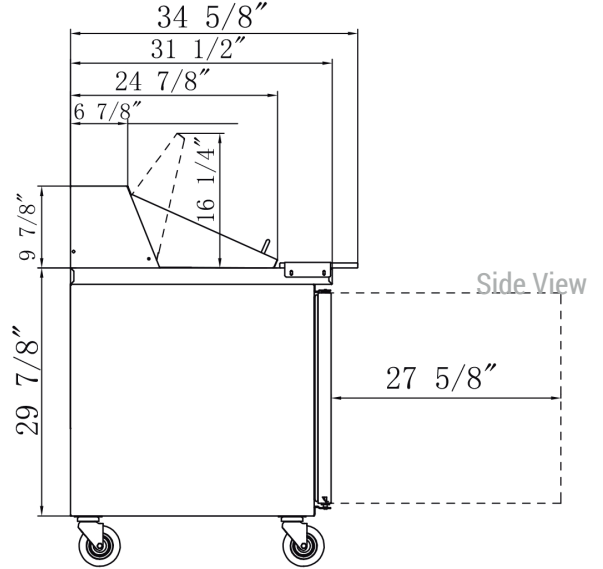
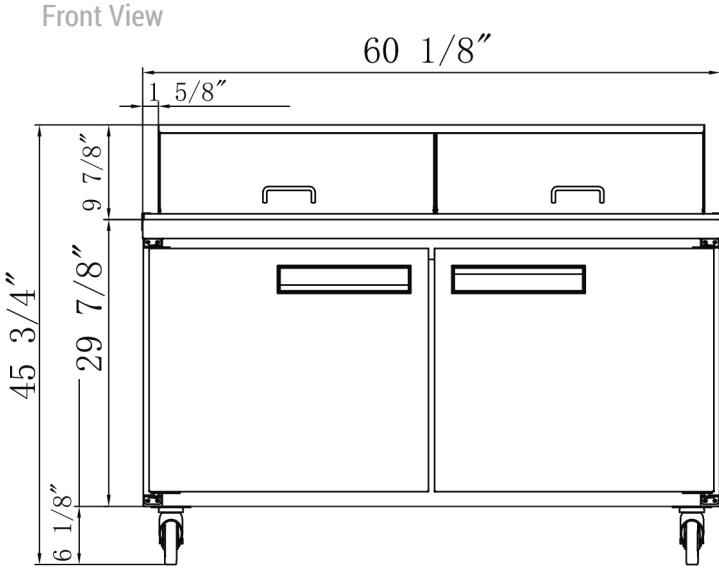

### MODEL DSP60-24M-S2

Cutting Board Size	60 x 9
Rated Voltage	115V
Rated Frequency	60Hz
Total Input Power	280W
Total Current	2.4A
Total Capacity	14.33 cu ft
Climatic Category	4-5
Protection Type	I
Design Pressure High Side	300 PSIG
Design Pressure Low Side	150 PSIG
Insulation Blowing Gas	C-Pentane
Refrigerant	R290/3.88 oz

### 1/6 PAN COUNT: 24

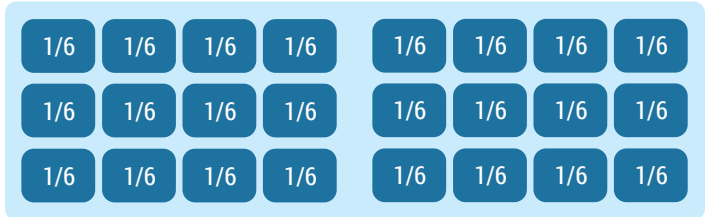

MODEL	EXTERNAL DIMENSION WXDXH (INCHES)	PACKAGING DIMENSION WXDXH (INCHES)	PRODUCT NET WEIGHT	# OF SHELVES	40HQ CONTAINER CERT.
DSP60-24M-S2	60 1/8 x 31 1/2 x 46	64 3/8 x 35 7/8 x 48 3/8	275 lbs	2	28



AutoQuotes



115/60/1  
NEMA-5-15P



Los Angeles | San Francisco | Dallas  
Houston | Florida | Chicago | New Jersey

1-800-931-8628

@ info@dukersusa.com

www.DukersUSA.com