



JOB _____ ITEM # _____

60" WIDE RANGES

Base Models: F3226, F33018, F33032



Model F33018-1RB-24B



Model F3226

Standard Features, Benefits & Options

OVENS: Medium ovens measure 26.5" w x 22" d x 14" h. Large oven measures 31.5" w x 22" d x 14" h for superior baking characteristics and results. Small oven measures 19.5" w x 22" d x 14" h. Heavy insulation for fuel efficiency. Easy cleaning porcelain and aluminized linings. One nickel plated rack. 3 rack positions with 2³/₄" between rack positions. Large and medium ovens are rated at 30,000 BTU, the small oven is 25,000 BTU. All oven burners are cast iron "H" pattern. Special "V" shaped baffle directs heat for excellent air circulation.

COOK TOPS: 24,000 BTU "star" pattern top burners with no gaskets to leak. The large 7" flame spread offers a more efficient burn pattern for small to large pots. Full width crumb trays catch all spillage. Top grates are 12" x 12" cast iron with spillover bowl that also reflects heat for added efficiency. Designed for easy movement of pots across top sections. Stainless steel bullnose-rail is safely flush with the cook tops and functional to straddle pots, skillets and plates and also serves as control protection.

CONSTRUCTION: Easy cleaning, corrosion resistant stainless steel finish, welded with angle iron and aluminized inner framing. Sturdy 6" heavy duty stainless pipe legs with adjustable feet. Double wall construction with heavy insulation for cooler operation. Installation clearances for non-combustible surfaces are 0" on sides and 0" in the rear, combustible surface clearances are 2" and 2".

CONTROLS: Include 500° thermostat, 100% safety shut off, automatic standing pilot and brass top burner valves. Pressure regulators are set at the factory for the gas specified. Optimal pressures are 4" WC for natural gas and 10" WC for propane. Manifold size is 3/4" NPT. All controls are tested and confirmed in good working order. Calibration and adjustments are the responsibility of the buyer.

GRIDDLES: 12" increments have 20,000 BTU cast iron burners replacing front to back open burner pairs. 18" & 30" sections feature 2 & 4 "I" burners respectively, rated at 18,000 BTU each, available only when matched together with 18" or 30" char-broilers. 3/4" thick is standard. SS splash guards tapering to 4". Front grease trough and large capacity grease catch. Optional raised griddle-cheesemelters with rear trough are available up to 36". Maximum rack clearance is 4 1/2".

CHAR-BROILERS: 12" increments have 25,000 BTU cast iron burners replacing front to back open burner pairs. 18" & 30" sections feature 2 & 4 "I" burners respectively, rated at 20,000 BTU each, available only when matched together with 18" or 30" griddles. Flare up reducing cast iron top grates and radiants for superior heat retention. Front grease trough and large capacity grease catch. SS splash guards tapering to 4". Char-broilers are approved for use in non-combustible locations only.

HOT TOPS: Available in 12" width increments in lieu of open top burners. 3/4" thick to hold heat from long life, even heating 20,000 BTU cast iron "H" pattern burners.

ACCESSORIES & OPTIONS: Casters, extra racks, pizza decks, FD oven thermostats, oven spark pilots, chrome griddle plates, 1" thick griddle plates, griddle thermostats, safety pilot griddles, lift off griddles, grill scrapers, cleaning supplies, hose and quick disconnects, control protection bars, storage base in lieu of oven and low backs are some of the standard options and accessories available.



Comstock-Castle Stove Co. • 119 W. Washington St. • Quincy, IL. 62301
Tel.: 217-223-5070 • Fax: 217-223-0007 • www.castlestove.com



60" RANGES MEASUREMENTS

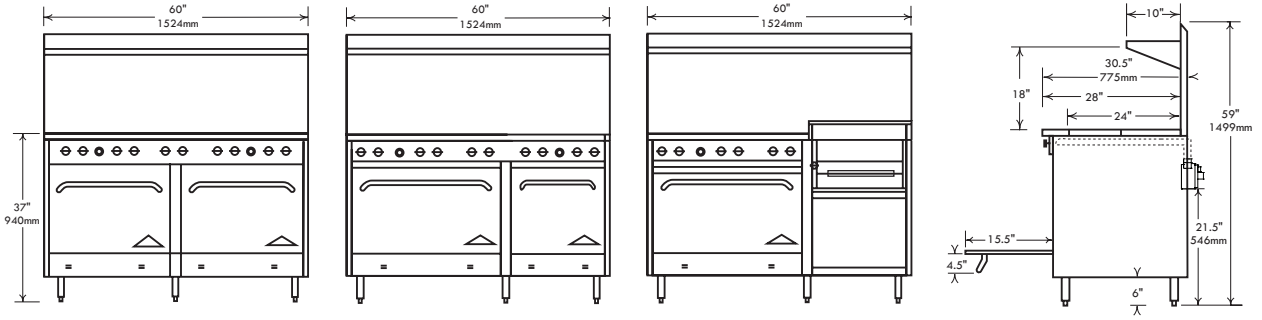

60" Ranges (Popular models shown below. Call factory for other model details.)

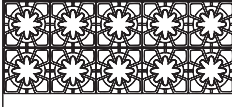
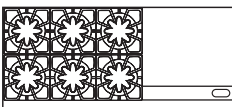
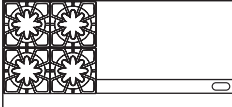
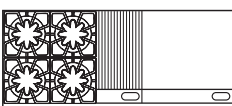
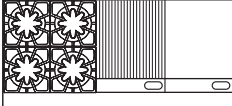
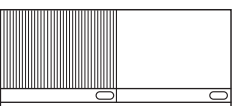
Cooktop Configuration	Model #	Description		Total B.T.U.	Approx. Wgt. Kg. / Lbs.
		Top	Base		
	F3226	(10) Open Burners	- w/ (2) 26.5" Ovens	300,000	377 / 830
	F33018	(10) Open Burners	- w/ (1) 31.5" & (1) 19.5" Oven	295,000	377 / 830
	F33032	(10) Open Burners	- w/ (1) 31.5" Oven & 22" storage space	270,000	332 / 730
	F3226-24	(6) Open Burners & (1) 24" Griddle	- w/ (2) 26.5" Ovens	244,000	409 / 900
	F33018-24	(6) Open Burners & (1) 24" Griddle	- w/ (1) 31.5" & (1) 19.5" Oven	239,000	409 / 900
	F33032-24	(6) Open Burners & (1) 24" Griddle	- w/ (1) 31.5" Oven & 22" storage space	214,000	364 / 800
	F3226-24B	(6) Open Burners & (1) 24" Raised Griddle, w/ 18" cheesemelter	- w/ (2) 26.5" Ovens	234,000	400 / 880
	F33018-24B	(6) Open Burners & (1) 24" Raised Griddle, w/ 18" cheesemelter	- w/ (1) 31.5" & (1) 19.5" Oven	229,000	400 / 880
	F33032-24B	(6) Open Burners & (1) 24" Griddle, w/ 18" cheesemelter	- w/ (1) 31.5" Oven & 22" storage space	204,000	355 / 780
	F3226-36	(4) Open Burners & (1) 36" Griddle	- w/ (2) 26.5" Ovens	216,000	432 / 950
	F33018-36	(4) Open Burners & (1) 36" Griddle	- w/ (1) 31.5" & (1) 19.5" Oven	211,000	432 / 950
	F33032-36	(4) Open Burners & (1) 36" Griddle	- w/ (1) 31.5" Oven & 22" storage space	186,000	386 / 850
	F3226-36B	(4) Open Burners & (1) 36" Raised Griddle, w/ 30" cheesemelter	- w/ (2) 26.5" Ovens	206,000	427 / 940
	F33018-36B	(4) Open Burners & (1) 36" Raised Griddle, w/ 30" cheesemelter	- w/ (1) 31.5" & (1) 19.5" Oven	201,000	427 / 940
*not ETL design listed					
	F3226-24-1RB	(4) Open Burners & (1) 24" Griddle & (1) 12" Char-Broiler	- w/ (2) 26.5" Ovens	221,000	427 / 1110
	F33018-24-1RB	(4) Open Burners & (1) 24" Griddle & (1) 12" Char-Broiler	- w/ (1) 31.5" & (1) 19.5" Oven	216,000	427 / 1110
	F33032-24-1RB	(4) Open Burners & (1) 24" Griddle & (1) 12" Char-Broiler	- w/ (1) 31.5" & 22" storage space	191,000	382 / 1010
	F3226-18-1.5RB	(4) Open Burners & (1) 18" Griddle & (1) 18" Char-Broiler	- w/ (2) 26.5" Ovens	232,000	425 / 935
	F33018-18-1.5RB	(4) Open Burners & (1) 18" Griddle & (1) 18" Char-Broiler	- w/ (1) 31.5" & (1) 19.5" Oven	227,000	427 / 940
	F33032-18-1.5RB	(4) Open Burners & (1) 18" Griddle & (1) 18" Char-Broiler	- w/ (1) 31.5" & (1) 19.5" Oven & 22" storage space	202,000	336 / 740
	F3226-30-2.5RB	(0) Open Burners & (1) 30" Griddle & (1) 30" Char-Broiler	-w/ (2) 26.5" Ovens	212,000	468 / 1030
	F33018-30-2.5RB	(0) Open Burners & (1) 30" Griddle & (1) 30" Char-Broiler	-w/ (1) 31.5" & (1) 19.5" Oven	207,000	468 / 1030
	F33032-30-2.5RB	(0) Open Burners & (1) 30" Griddle & (1) 30" Char-Broiler	-w/ (1) 31.5" & 22" storage space	182,000	423 / 930

Note: Radiant char-broiler sections and hot tops available, add suffix -1RB, -2RB or -1HT, -2HT, etc. per section.

Top sections in lieu of open top burners are located on the right as viewed from the front. Special locations may require custom work & pricing, please call for details.
Approximate Packaging Dimensions: 67" (1702mm) Wide x 41" (1041mm) Deep x 40" (1016mm) High.

NOTICE: In an ongoing effort of product development & improvement, Comstock-Castle reserves the right to change specifications and product design without notice. Such modifications do not entitle the buyer to corresponding changes or replacements for previously purchased equipment.