

SANIWALL™ & SANISTAND™ Touchless Sanitizer Automated Dispenser

SANIWALL™ Wall Mount



Product Dimensions
H 18" x W 6" x D 4.5"
Type: LIQUID/GEL
SKU: 200-SANIWALL01



*Requires 4x C-size batteries.
Not included*

STEP 1

Open it with key, take out the bottle and pump

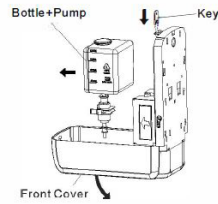

Install Black Holder

STEP 2

Install the back holder with dispenser

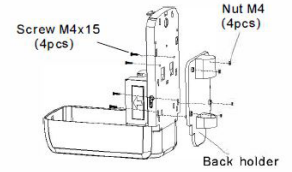

STEP 3

Put Advertising photo inside of 2 pcs AD board

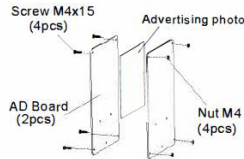

* Advertising photo size: 18x 18cm

Install AD Board (If needed)

STEP 4

Install the AD Board on dispenser

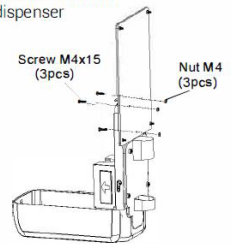

SANISTAND™ Wall Mount



Product Dimensions:
H 59" x W 6" x D 4.5"
Type: LIQUID/GEL
SKU: 200-SANISTAND01



*Requires 4x C-size batteries.
Not included*

STEP 5

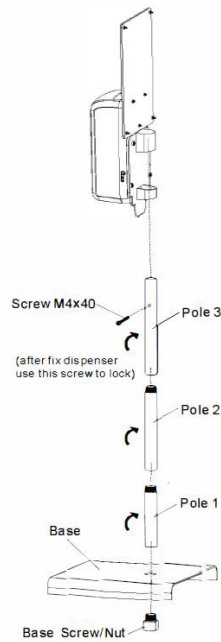

Install Pole and Base

STEP 6

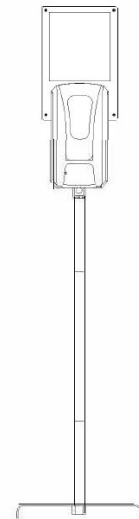

* fix 4 pcs C size batteries,
fill liquid and turn on the
switch.

MVP GROUP, LLC

12000 Biscayne Blvd., Suite 108

Miami, Florida 33181

Tel. 786.600.4687 / Fax: 786.661.4100 | Email: sales@mvpgroupcorp.com

STEP 1

Open it with key, take out the bottle and pump

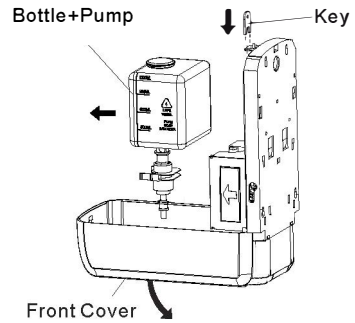

Install Back Holder

STEP 2

Install the back holder with dispenser

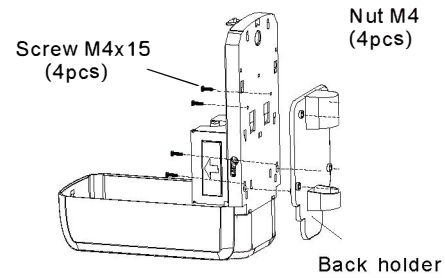

STEP 5

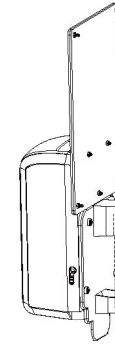

Screw M4x40 Pole 3

(after fix dispenser use this screw to lock)

Pole 2

Pole 1

Base

Base Screw/Nut

STEP 6

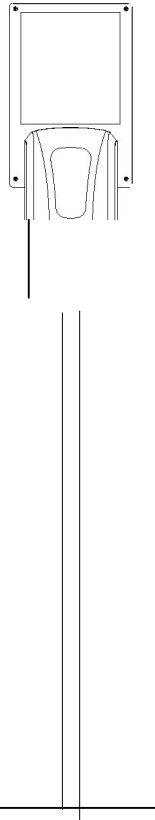

* fix 4 pcs C size batteries, fill liquid and turn on the switch.

STEP 3

Put Advertising photo inside of 2 pcs AD board

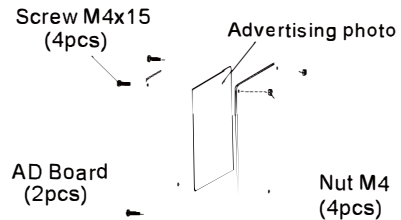

* Advertising photo size: 18x 18cm

Install AD Board (If Needed)

STEP 4

Install the AD Board on dispenser

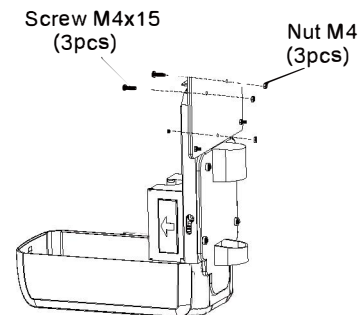

Install Pole and Base